









	29 V _~
	7 mA
	4 x (Ø 0,6 mm <  < Ø 0,8 mm)
	-5°C → +45°C
	 PIR
	150 lux
	15 mn
	Auto ON/OFF
	 3 m x 24 m







1

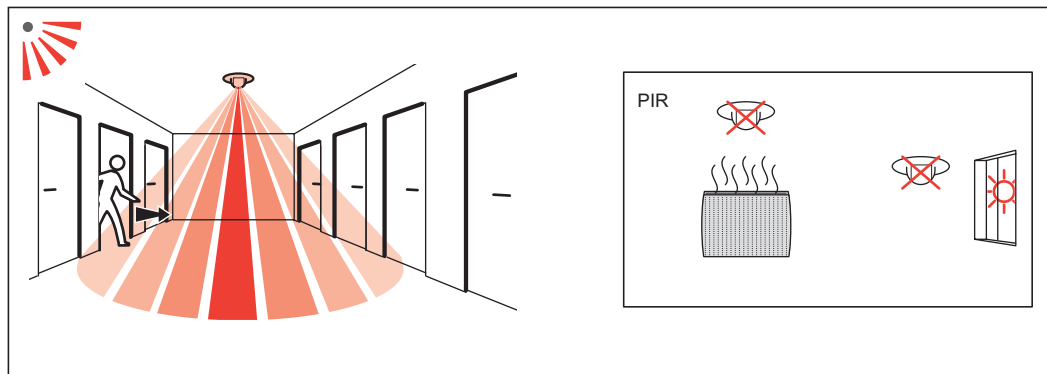
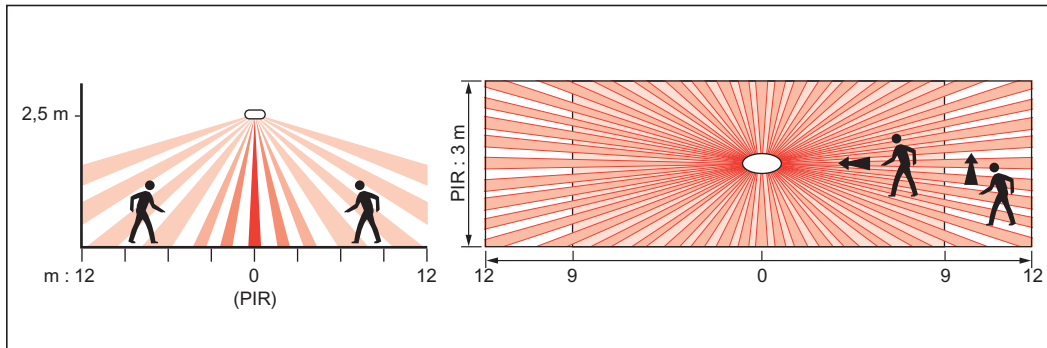
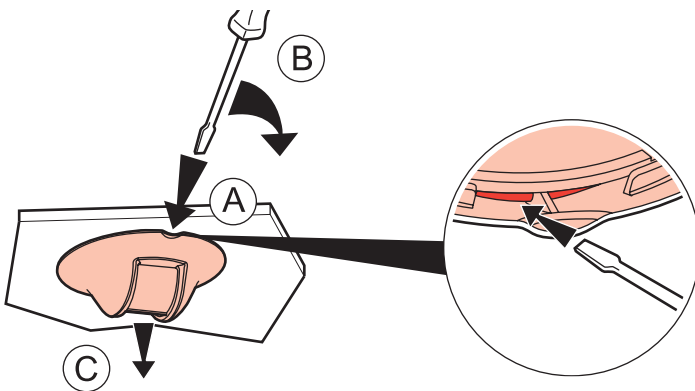
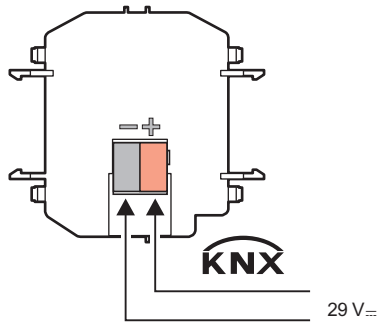
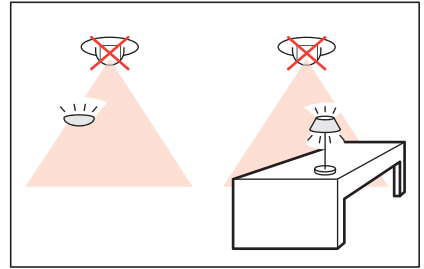
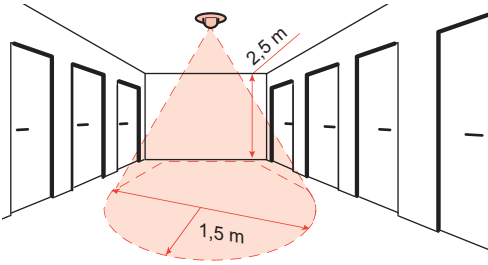
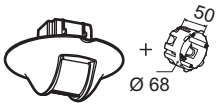
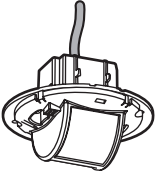

2

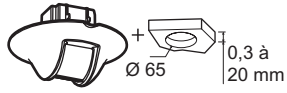
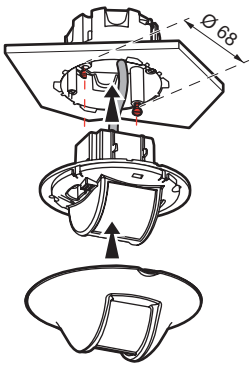

1

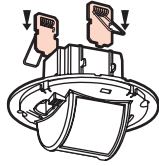

2

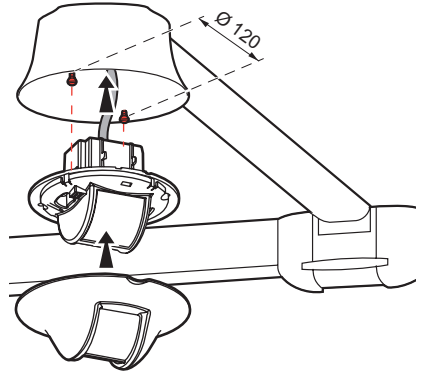
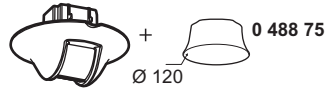
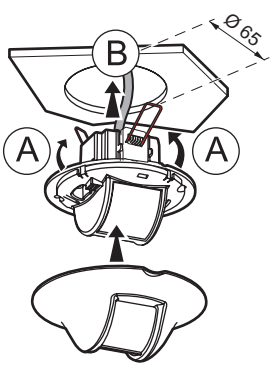



Auto ON/OFF



Manual ON / Auto OFF



www.legrandoc.com

	5 - 1275 lux
	5 sec - 17h 59 min 59 sec
	25% - 50% - 75% - 100%
Mode	Auto ON/OFF - Manual On/Auto OFF - Walkthrough

- Bouton de prog. KNX
- KNX prog. push-button
- Pulsante prog. KNX

- LED KNX
- KNX LED
- LED KNX

- Cellule de luminosité
- Daylight sensor
- Cellula di luminosità

- LED d'émission/ de réception IR
- IR reception/ transmission LED
- LED di trasmissione/ ricezione IR

- LED de détection
- Motion led
- LED rilevazione movimento

- Capteur PIR
- PIR sensor
- Sensore PIR

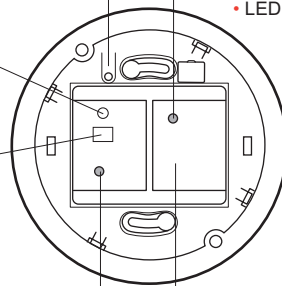

* 0 882 30
BMSO4001

* Version minimum du firmware 2.5.6, mise à jour disponible sur www.legrandoc.com
 • Minimum version of 2.5.6 firmware update available on www.legrandoc.com
 • Versione minima del firmware 2.5.6, software di aggiornamento disponibile su www.legrandoc.com

